



bernette 30 Serie

Produktmanagement bernette
Steckborn

bernette
SWISS DESIGN

bernette 30 Serie

- ✓ Markteinführung ab April 2017
- ✓ Ersetzt bernette London, Rome Serie
- ✓ Qualitätsprodukt, direkt unter dem BERNINA-Segment
- ✓ Zwei mechanische Modelle (b33 und b35)
- ✓ Zwei Computermodele (b37 und b38)





Konzept der neuen bernette-Modelle

- Gesamtheitliches Produktportfolio:
 - Ergänzend zur Nähmaschinen b30 Serie: Overlocker b40 Serie
 - Einheitliches Design und abgestimmte Marketingsprache
- Produkt- und Qualitätsverbesserung:
 - Erweiterte Leistungen rund ums Produkt (Marketing, Zubehör)
 - Höhere Positionierung von bernette
- Swiss Design:
 - Designidee: «Stoff, welcher über die Maschine gleitet»
 - Premium Swiss Design: modern, elegant und edel
 - BERNINA Designandeutungen (Ähnlichkeiten)





b33

b35





b33

b35

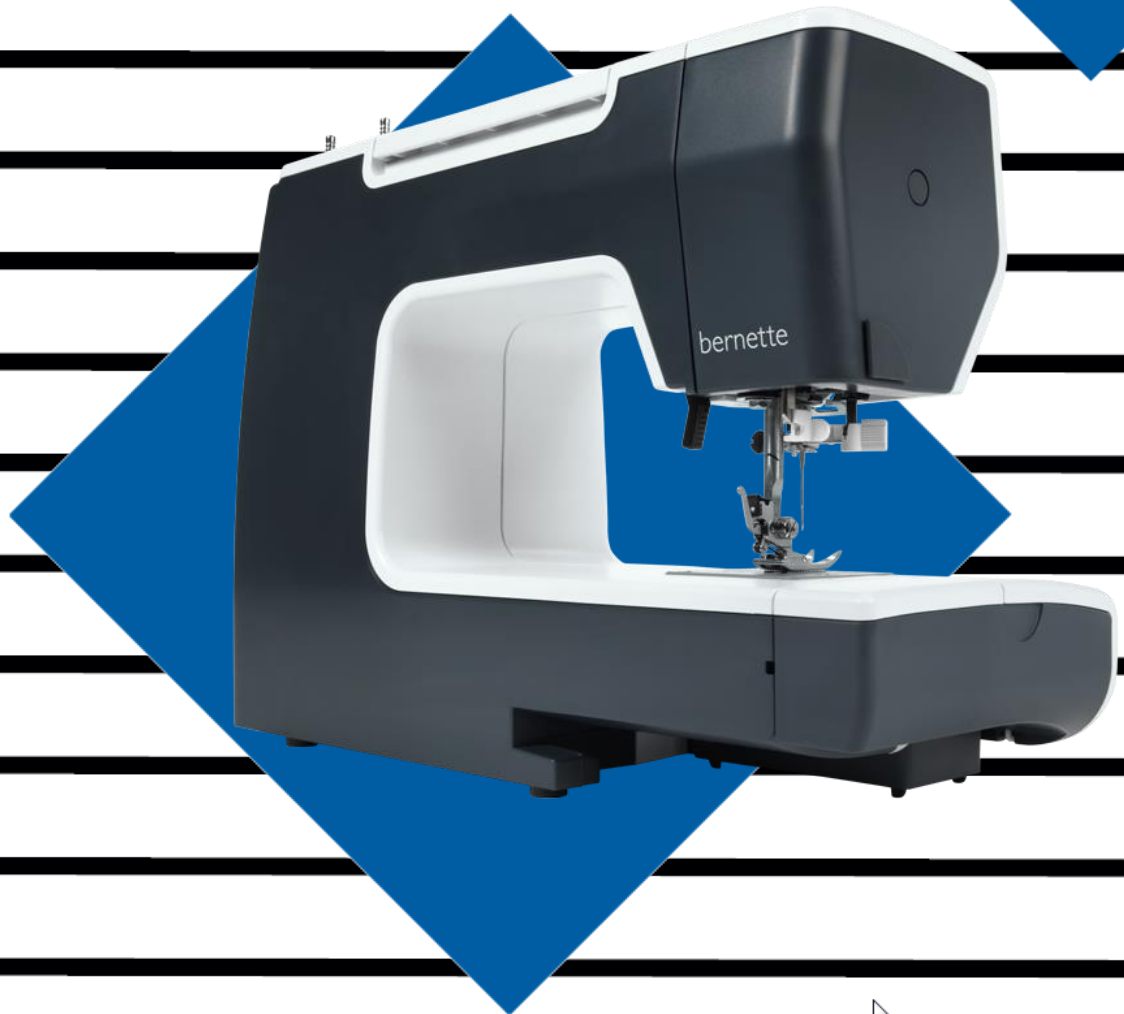

bernette 33 - Produkteigenschaften



4-stufiges Knopfloch

Der Nadeinfädler hilft beim Einfädeln des Fadens

Zuverlässiger CB-Greifer mit 5 mm Stichbreite

Praktischer Stauraum für Zubehör direkt im Freiarm

Aufgedrucktes Lineal für schnelle Abmessungen



2 Drehknöpfe

Stichübersicht auf einen Blick

Rückwärtsnähehebel

Nähgeschwindigkeit von 860spm

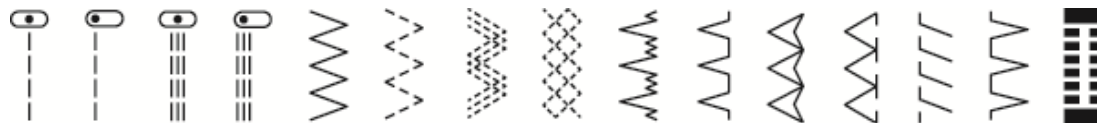

bernette 35 - Zusätzliche Produkteigenschaften

1-stufiges Knopfloch



QR-Code zur
Nähanleitung einer
Nähmaschinenhülle



3 Drehknöpfe
inkl. Stichbreitenverstellung



bernette

SWISS DESIGN



b37

b38





b37

b38



bernette 37 - Produkteigenschaften



Nadelstopp oben/unten – individuell einstellbare Position der Nadel

Der Nadeleinfädler hilft beim Einfädeln des Fadens

Drop-in Greifer mit 7 mm Stichbreite

Praktischer Stauraum für Zubehör direkt im Freiarm

Aufgedrucktes Lineal für schnelle Abmessungen



Geschwindigkeitsregler für eine individuelle Nähgeschwindigkeit

Vernähfunktion, zum direkten und schnellen Sichern der Naht

Start/Stopp-Taste, zum Nähen ohne Fusspedal

Schublade mit Stichübersicht und Kurzanleitung

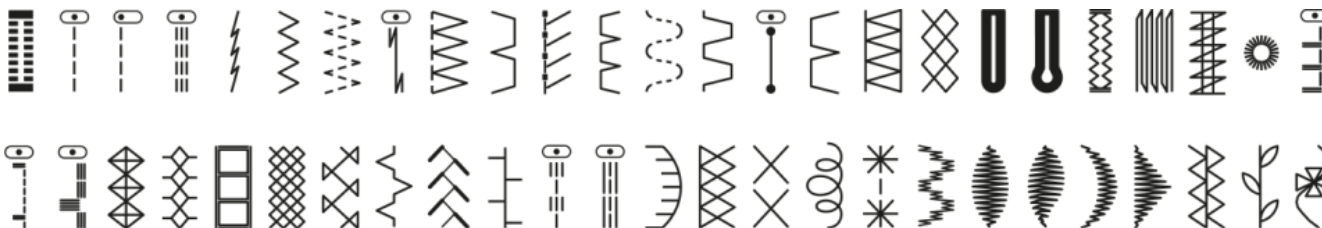

bernette
SWISS DESIGN

bernette 38 - Zusätzliche Produkteigenschaften

b38

Automatisches Schneiden des Fadens

LCD-Display für beste Übersicht aller Einstellungen



+ inkl. Anschietisch



Stich-Direktanwahl über Tasten

Zwillingsnadel-Sicherheitsfunktion



+ inkl. fester Staubschutzhaube



+ 3 Alphabete (ca. 80 Stiche je): Lateinische, Kyrillische und Sonderzeichen

bernette

SWISS DESIGN









Merkmaleübersicht der b30 Serie

Allgemeine Funktionen	b33	b35	b37	b38
Maschinentyp	Mechanisch	Mechanisch	Computer	Computer
Bedienung	2 Drehknöpfe	3 Drehknöpfe	LCD-Display	LCD-Display
Greifersystem	CB	CB	Drop-in	Drop-in
Länge Freiarm rechts neben der Nadel	170 mm	170 mm	170 mm	170 mm
Max. Nähgeschwindigkeit (Stiche pro Minute)	860 spm	860 spm	700 spm	820 spm
Oberfadenspannung manuell einstellbar	✓	✓	✓	✓
Nähfussdruck manuell einstellbar	-	-	-	✓
Manueller Fadenabschneider	✓	✓	✓	✓
Automatischer Fadenabschneider	-	-	-	✓
Start/Stopp-Taste	-	-	✓	✓
Nählicht	LED	LED	LED	LED
Nadeleinfädler	✓	✓	✓	✓
Nadelstopp oben/unten	-	-	✓	✓
Zwillingsnadelfähig	✓	✓	✓	✓
Geschwindigkeitsregler	-	-	✓	✓
2-stufiger Nähfusslifter	✓	✓	✓	✓
Elektrischer Fussanlasser	✓	✓	✓	✓
Anzahl Stichmuster gesamt	15	23	50	394
Anzahl Knopflöcher inkl. Ösen	1 (4-stufig)	1 (1-stufig)	5 (1-stufig)	8 (1-stufig)
Nutzstiche inkl. Stretchstiche	14	14	17	20
Stopfstiche	-	-	2	2
Zierstiche	-	8	19	67
Quiltstiche	-	-	7	25
Alphabet	-	-	-	3 (inklusive Kyrillisch)
Maximale Stichbreite	5 mm	5 mm	7 mm	7 mm
Maximale Stichlänge	4 mm	4 mm	5 mm	5 mm
Versenkbarer Transporteur	✓	✓	✓	✓
Memory	-	-	-	✓
Automatischer Unterfadenspuler	✓	✓	✓	✓
Automatische Vernähfunktion	-	-	✓	✓
Standardzubehör				
Nähfüsse (Sohlen)	5	7	5	8
Anschiebetisch	-	-	Optional	✓
Staubschutzhaube	-	-	Softcover	Hardcover

Standardzubehör









b33: 5 Standard Nähfüsse

b35: 7 Standard Nähfüsse

Sewing Feet / Nähfuss /Pied	Image	b33	b35
Zigzag foot Zickzack-Nähfuss Pied pour zigzag		X	X
Blindstitch foot Blindstichfuss Pied pour points invisibles		X	X
Button-sew-on foot Knopfannähfuss Pied pour boutons		X	X
Zipper foot Reissverschlussfuss Pied pour fermeture à glissière		X	X
Buttonhole foot with slide Knopflochschlittenfuss Pied traîneau pour boutonnière		X	
Buttonhole foot with slide Knopflochschlittenfuss Pied traîneau pour boutonnière			X
Hemmer foot Säumerfuss Pied ourleur			X
Embroidery foot with clear sole Stickfuss mit transparenter Sohle Pied pour broderie avec semelle transparente			X

b37: 5 Standard Nähfüsse















b38: 8 Standard Nähfüsse

Sewing Feet / Nähfuss /Pied	Image	b37	b38
Zigzag foot Zickzack-Nähfuss Pied pour zigzag		X	X
Blindstitch foot Blindstichfuss Pied pour points invisibles			X
Button-sew-on foot Knopfannähfuss Pied pour boutons		X	X
Zipper foot Reissverschlussfuss Pied pour fermeture à glissière		X	X
Buttonhole foot with slide Knopflochschlittenfuss Pied traîneau pour boutonnière		X	X
Open embroidery foot Offener Stickfuss Pied ouvert pour broderie			X
Embroidery foot with clear sole Stickfuss mit transparenter Sohle Pied pour broderie avec semelle transparente		X	X
Overlock foot Overlockfuss Pied pour surjet			X

bernette



















SWISS DESIGN

Optionales Zubehör - b33 und b35

Sewing Feet / Nähfuss / Pied	Image	b33	b35	bernette Portfolio
Open embroidery foot Offener Stickfuss Pied ouvert pour broderie		•	•	NEW
Overlock foot Overlockfuss Pied pour surjet		•	•	✓
Straight-stitch foot Geradstichfuss Pied pour point droit		•	•	NEW
Hemmer foot Säumerfuss Pied ourleur		•	X	✓
Zigzag foot with non-stick sole Zickzack-Nähfuss mit Gleitsohle Pied pour zigzag avec semelle de glissement		•	•	NEW
Invisible-zipper foot Reissverschlussfuss für nahtverdeckte Reissverschlüsse Pied pour fermeture à glissière invisible		•	•	✓
Cording foot Kordelfuss Pied pour cordon		•	•	✓
Embroidery foot Stickfuss Pied pour broderie		•	•	✓
Embroidery foot with clear sole Stickfuss mit transparenter Sohle Pied pour broderie avec semelle transparente		•	X	✓
Binder attachment for pre-folded bias tape Bandeinfasser für vorgefaltete Bänder Ourleur simple pour biais prépliés		•	•	NEW
Right seam guide Kantenlineal rechts Guide droit		•	•	✓
Walking foot Obertransportfuss Pied d'avancement supérieur		•	•	✓
Darning- / Embroidery foot Stopf- / Stickfuss Pied pour reprise / broderie		•	•	✓
Patchwork foot Patchworkfuss Pied pour patchwork		•	•	✓
Gathering foot Kräuselfuss Pied pour fronces		•	•	✓

- X Standardzubehör
- Sonderzubehör

Optionales Zubehör - b37 und b38

Sewing Feet / Nähfuss / Pied	Image	b37	b38	bernette Portfolio
Fabric-feeding aid for sewing buttonholes Transporthilfe zum Knopflochnähen Aide d'avancement pour la couture des boutonnières		●	●	NEW
Free-motion embroidery foot Freihandstickfuss Pied pour broderie à mains libres		●	●	✓
Darning- / Embroidery foot Stopf- / Stickfuss Pied pour reprise / broderie		●	●	✓
Straight-stitch foot Geradstickfuss Pied pour point droit		●	●	✓
Blindstitch foot Blindstickfuss Pied pour points invisibles		●	X	✓
Overlock foot Overlockfuss Pied pour surjet		●	X	✓
Open embroidery foot Offener Stickfuss Pied ouvert pour broderie		X	X	NEW
Gathering foot Kräuselfuss Pied pour fronces		●	●	✓
Cording foot Kordelfuss Pied pour cordon		●	●	✓
Ribbon-couching foot Bandannähfuss Pied pour la couture de ruban		X	X	NEW
Invisible-zipper foot Reissverschlussfuss für nahtverdeckte Reissverschlüsse Pied pour fermeture à glissière invisible		●	●	✓
Walking foot Obertransportfuss Pied d'avancement supérieur		●	●	✓
Right seam guide Kantenlineal rechts Guide droit		●	●	✓
Edgestitch foot Schmalkantfuss Pied pour bordure étroite		●	●	NEW
Zigzag foot with non-stick sole Zickzack-Nähfuss mit Gleitsole Pied pour zigzag avec semelle de glissement		●	●	NEW
Binder attachment for pre-folded bias tape Bandeinfasser für vorgefaltete Bänder Ourleur simple pour biais prépliés		●	●	NEW
Patchwork foot Patchworkfuss Pied pour patchwork		●	●	✓
Hemmer foot Säumerfuss Pied ourleur		●	●	✓

X Standardzubehör

● Sonderzubehör

Vorschau: Zubehörverpackung

- Alle Nähfüsse werden in einer Blisterverpackung ausgeliefert
- Zubehörkatalog ist bereits aktualisiert
- Verfügbarkeit Optional Zubehör: Juni 2017



Maschinenverpackung und Anleitung



Alle Modelle werden mit einer schwarz-weißen Anleitung und einem Farbkarton ausgeliefert.

Leporello und Poster verfügbar



bernette 37

The bernette 37 is the smaller of the two bernette computer models. It offers an extensive range of helpful functions and impressive stitch quality. 50 stitches with a maximum stitch width of 7 mm are available, including decorative and stretch stitches as well as buttonholes. With the practical start/stop function, the sewing process can also be controlled without the foot control. With the needle stop up/down, the needle position can be determined at a sewing stop, which is a particular advantage when sewing corners. The sewing speed can be individually adjusted as needed and the sewing area is optimally illuminated thanks to the bright LED light. Five presser feet (soles) are included in the package.



bernette 38

The computer bernette 38 is the top model in the series. It offers everything that creative sewists need. A total of 394 stitches are available, including 67 decorative stitches, 3 alphabets and 8 buttonholes as well as practical stitches such as a stretch stitch for stretchy fabrics. The maximum stitch width is 7 mm. In addition to practical functions such as the speed regulator, start/stop and the needle stop up/down, the bernette 38 has a bright sewing light, a needle threader, and an automatic and manual thread cutter. The package includes 8 presser feet (soles) and a large extension table.

Stitch Overview



Stitch Overview



Do you want to be creative and sew your own things? Or alter and embellish your clothing? Then the new bernette models in the stylish two-color Swiss design are perfect for you! They are easy to use, have numerous functions with excellent stitch quality, and are durable as well as affordably priced. Experience creative sewing fun at a high level and don't settle for less.

- Automatic thread cutter
- Needle stop up/down – individually adjustable needle position
- The threader helps with threading the needle
- Bright LED light
- Practical storage space for accessories, directly in the free arm
- Imprinted ruler for fast measurements
- Twin needle safety function when changing from one to twin needles
- LCD display for best view of all settings
- Direct stitch selection via buttons
- Speed regulator for individual sewing speed
- Darning function for direct and quick securing of a stitch
- Start/stop button for sewing without the foot control
- Practical drop-in hook with 7 mm stitch width
- Drawer with stitch overview and Quick Start Guide

bernette 38

bernette
SWISS DESIGN



DIY: bernette dust cover

Start your first sewing project right away and sew this practical dust cover for your new bernette to give it an individual look. With this, your bernette will be beautifully and stylishly packaged when you are not sewing. Let's go! Select your favorite fabric - cut - sew - be proud of your work! The instructions for this easy project are available at www.mybernette.com/cover



bernette 33

The bernette 33 is the smaller of the two mechanical bernette models. As a basic model, it is particularly suited for beginners with little experience. Adjustments can be made with the two knobs at the front. The stitch package contains 15 stitches with a maximum stitch width of 5 mm. A needle threader and a manual thread cutter ensure fast and uncomplicated sewing. Five different presser feet (soles) are included in the package.



bernette 35

The bernette 35 is a mechanical model without computer control. With utility and decorative stitches, the stitch package has a total of 23 stitches, with a maximum stitch width of 5 mm, including an automatic buttonhole. All settings such as thread tension, stitch width and stitch length, as well as the selection of a stitch, can be made with the three knobs at the front. The manual needle threader and thread cutter enable efficient sewing. The bernette 35 package includes 7 presser feet (soles).

Stitch Overview

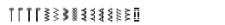

Stitch Overview



www.mybernette.com

EN 0017

General Functions	b33	b35	b37	b38
Machine type	Mechanical	Mechanical	Computer	Computer
Construction	2 needs	2 needs	100 steps	100 steps
Hook system	CS	CS	Drop-in	Drop-in
Free arm length to the right of the needle	170 mm	170 mm	170 mm	172 mm
Max. sewing speed (stitch per minute)	800 gpm	800 gpm	700 gpm	820 gpm
Upper thread tension manually adjustable	✓	✓	✓	✓
Foot pressure manually adjustable	–	–	–	–
Manual thread cutter	✓	✓	✓	✓
Automatic thread cutter	–	–	–	✓
Start/stop button	–	–	–	✓
Sewing light/LED	LED	LED	LED	LED
Throat	✓	✓	✓	✓
Needle stop up/down	–	–	–	✓
Twin needles capability	–	–	✓	✓
Speed regulator	–	–	✓	✓
2-step presser foot rise	–	–	✓	✓
Basic buttonhole	–	–	✓	✓
Total number of stitch patterns	15	23	50	394
Buttonhole including equate	1 (4 steps)	1 (1 step)	5 (1 step)	8 (1 step)
Utility stitches including stretch stitches	14	14	17	20
Darning stitches	–	–	2	2
Embroidery stitches	–	8	19	67
Quilt stitches	–	–	2	25
Alphabet	–	–	–	3 (including QUILT)
Maximum stitch width	5 mm	5 mm	7 mm	7 mm
Maximum stitch length	4 mm	4 mm	5 mm	5 mm
Retractable head drop	–	–	✓	–
Memory	–	–	–	–
Automatic bobbin winder	✓	✓	–	–
Automatic securing function	–	–	–	–
Standard Accessories				
Presser Feet (soles)	5	7	5	8
Extension table	–	–	Optional	–
Footcase	–	–	Software	Hardware

Not all models and accessories are available in all countries. Subject to change without regard to equipment and design.

Discover the four new and affordable bernette models with Swiss Design

bernette
for my ideas

Nähprojekte und How-to-videos

- Nähprojekte inkl. Anleitung und How-to-Video:
 - Blaues Kleid für die Modelle b33 und b35
 - Rotes Kleid für die Modelle b37 und b38
 - Maschinenstaubschutzhaube



www.mybernette.com/red-dress



www.mybernette.com/blue-jeans

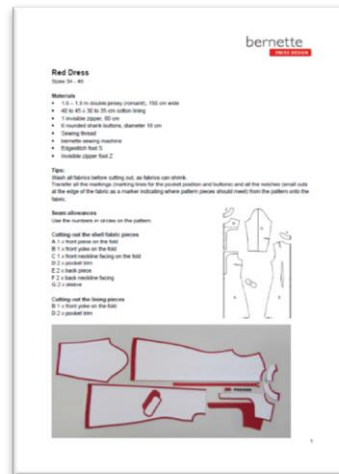

- How-to-videos für die Maschinenbedienung
- All Videos werden auf der bernette-website und dem [bernette YouTube](https://www.youtube.com/bernette)-Kanal veröffentlicht sobald verfügbar.

bernette Kampagne: Nähprojekt Staubschutzhaube

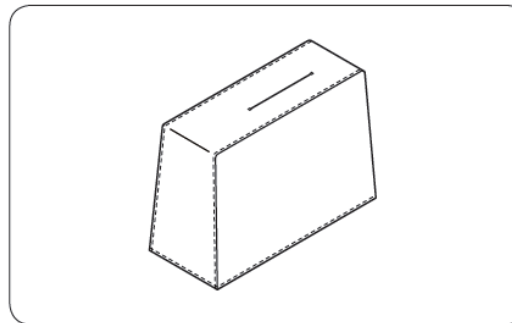

Staubschutzhaube

Nähanleitung zur eigenen individuellen Staubschutzhaube auf:



www.mybernette.com/staubschutzhaube

www.mybernette.com/cover

Aktualisierung der mybernette.com

Homepage

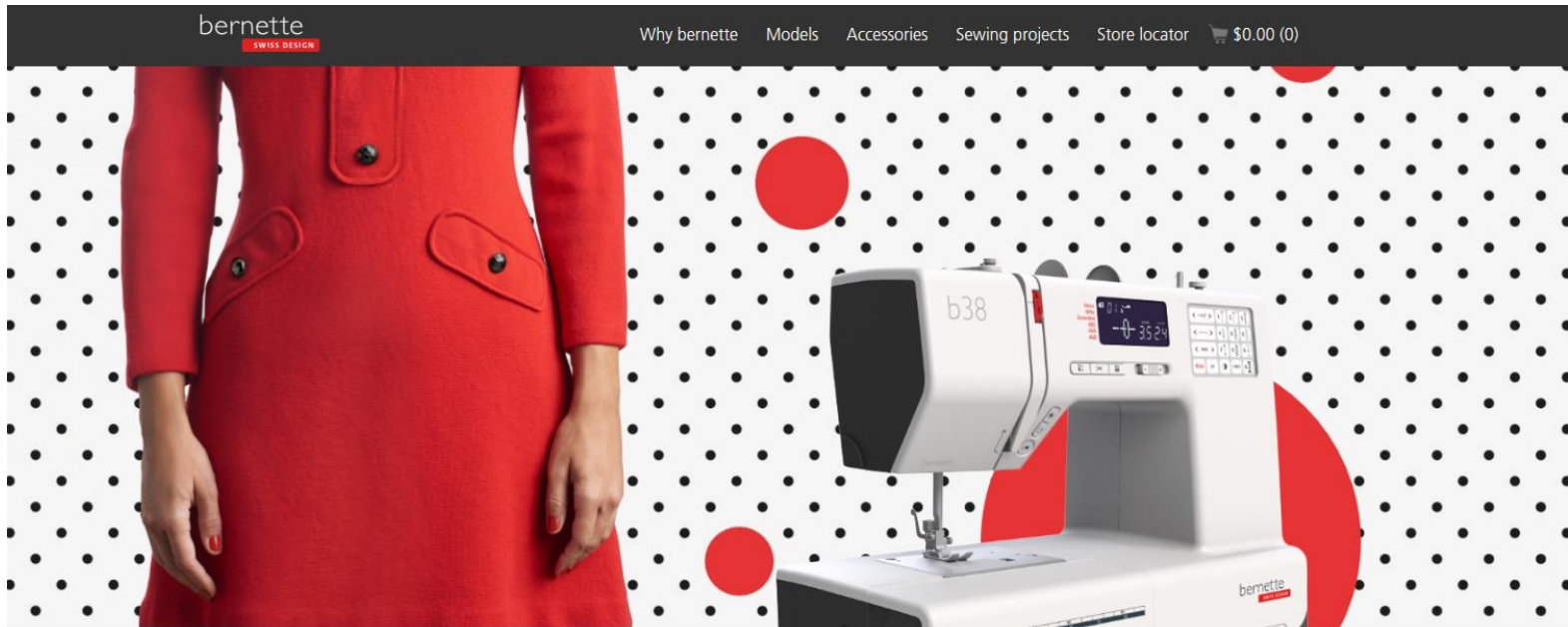

bernette 38

The bernette 38 is the top model in the bernette series. This computerized sewing machine offers a wide range of functions at an affordable price – leaving nothing to be desired. As the top model, this impressive sewing machine also has a bright LED sewing light, a needle threader and both an automatic and a manual thread cutter. The bernette 38 comes with eight different presser feet (soles) and a large extension table as standard.

[Go to the machine](#)